

# WORKSTEAD

## INSTALLATION INSTRUCTIONS | ORBIT CHANDELIER

---



### GENERAL NOTES

This luminaire is UL, cUL, and CE listed for installation in dry or damp locations.

When installing luminaire, conform to all applicable local electrical codes, ordinances, and the National Electrical Code (NEC).

For your safety and proper operation of luminaire, read and understand all instructions completely before commencing installation of this luminaire.

Carefully unpack the luminaire and inspect for damage.

Use the enclosed gloves when handling the luminaire.

This product is rated for four (4) 60W max E12 G16 bulbs (or E14 G50 bulbs, depending on your location).

Save these instructions for future reference.

### CAUTION









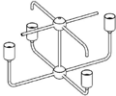

This product should be installed only by a licensed electrician.

### WARNING

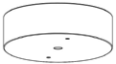
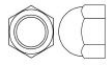
The electricity must be turned off at the main fuse box before installing this luminaire. Turning power off using the light switch may not be sufficient to prevent electrical shock.

Use UL listed wire nuts for all wiring connections in this luminaire. Wrap wire nut connections with UL listed electrical tape.

### INCLUDED COMPONENTS FOR INSTALLATION

	(1) luminaire body
	(1) stem assembly
	(2) large reflectors
	(2) small reflectors
	(1) canopy
	(2) acorn nuts
	(4) E12/E14 bulbs
	(1) tube of Loctite
	(2) 1-3/4" #8 x 32 machine screws
	(2) 1-1/2" #8 x 32 machine screws
	(3) wire nuts
	(1) Allen wrench

### ASSEMBLY AND MOUNTING INSTRUCTIONS

#### STEP 1 | CUT POWER

Shut off the main electrical supply to the junction box from the fuse box/circuit breaker. Turning power off at the switch is not sufficient.

#### STEP 2 | ASSEMBLE SUSPENSION

Install the (2) 1-3/4" #8 machine screws provided into the outer holes of the mounting plate, from the back side, to act as mounting studs. Then slide the canopy onto the suspension stem assembly all the way up to the top of the stem, being careful not to scratch the finish. Carefully align the two holes in the canopy with the mounting stud screws and slip the canopy over those screws. Attach and tighten the two acorn nuts provided to those screws. **NOTE:** Tighten acorn nuts by hand or using soft-touch pliers. (Fig. 1)

#### STEP 3 | FEED WIRES

Feed the wires up the suspension stem and canopy assembly. Once the wires exit the top of the suspension assembly, apply one *small* drop of the Loctite provided onto the threaded nipple and thread the suspension assembly onto the hub of the luminaire body. (Fig. 2)

#### STEP 4 | MOVE CANOPY

Remove the acorn nuts at the canopy. Slide the canopy down the suspension stem, being careful not to scratch the finish, and let the canopy rest on the top of the luminaire body.

#### STEP 5 | ATTACH MOUNTING PLATE

Locate the junction box in the ceiling. Attach the assembled luminaire via the mounting plate to the junction box using the (2) 1-1/2" #8 machine screws provided. (Fig. 3)

Fig. 1

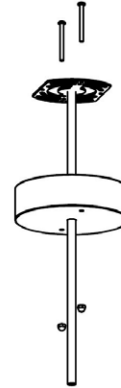

Fig. 2

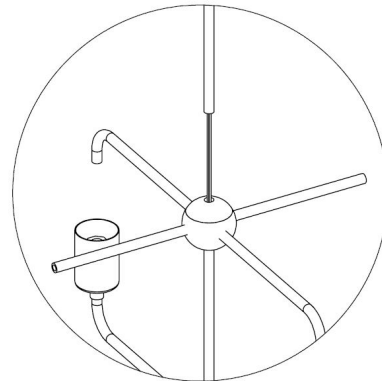
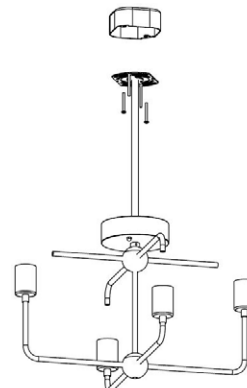

Fig. 3



### ASSEMBLY AND MOUNTING INSTRUCTIONS

#### STEP 6 | CONNECT WIRES

Using the wire nuts provided, make electrical connections by following the electrical configuration table. (Fig. 4) Ensure that all electrical connections are wrapped with UL listed electrical tape.

#### STEP 7 | SECURE CANOPY

Carefully tuck the wiring into the junction box. Carefully align the two holes in the canopy with the mounting stud screws and slip the canopy over those screws. Reattach and re-tighten the two acorn nuts to those screws to secure the luminaire to the ceiling. NOTE: Tighten acorn nuts by hand or using soft-touch pliers.

#### STEP 8 | INSTALL REFLECTORS

One at a time, screw the two large reflectors onto the ends of the straight arms and the two small reflectors onto the ends of the bent arms. Secure each reflector to its respective arm by tightening the set screw at the reflector's collar using the Allen wrench provided. (Fig. 5)

#### STEP 9 | INSTALL BULBS

Install the bulbs provided. Return power to the luminaire to confirm proper function. If further work is needed, be sure to turn off power to luminaire before proceeding. NOTE: minor adjustments for reflector/bulb alignment may be necessary if components shifted during transit.

Fig. 4

FROM SUPPLY	TO LUMINAIRE
Connect black or red (hot) house supply circuit wire to:	Luminaire black wire (hot)
Connect white (neutral) house supply circuit wire to:	Luminaire white wire (neutral)
Connect green insulated or bare copper (ground) house supply circuit wire to:	Luminaire bare copper wire (ground)

Fig. 5

