



General Notes

THIS LUMINAIRE IS UL LISTED. WHEN INSTALLING LUMINAIRE, CONFORM TO ALL APPLICABLE LOCAL ELECTRICAL CODES, ORDINANCES, AND THE NATIONAL ELECTRICAL CODE (NEC).

FOR YOUR SAFETY AND PROPER OPERATION OF LUMINAIRE, READ AND UNDERSTAND ALL INSTRUCTIONS COMPLETELY BEFORE COMMENCING INSTALLATION OF THIS LUMINAIRE.

CAREFULLY UNPACK THE LUMINAIRE AND INSPECT FOR DAMAGE.

THIS PRODUCT IS RATED FOR ONE 40W MAX, GLOBE BULB.

SAVE THESE INSTRUCTIONS FOR FUTURE REFERENCE.

CAUTION

THIS PRODUCT SHOULD BE INSTALLED ONLY BY A LICENSED ELECTRICIAN.



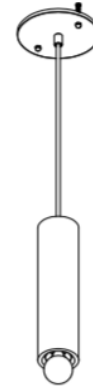

WARNING

THE ELECTRICITY MUST BE TURNED OFF AT THE MAIN FUSE BOX BEFORE INSTALLING THIS LUMINAIRE. TURNING POWER OFF USING THE LIGHT SWITCH MAY NOT BE SUFFICIENT TO PREVENT ELECTRICAL SHOCK.

USE UL LISTED WIRE NUTS FOR THE WIRING CONNECTIONS IN THIS LUMINAIRE. WRAP WIRE NUT CONNECTIONS WITH UL LISTED ELECTRICAL TAPE.

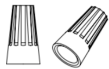

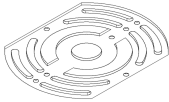
Included components

2	wire nuts	
4	1 1/2" 8# x 32 machine bolts	
2	Acorn Nuts	
1	universal crossbar	
1	Tala bulb	



Final Assembly

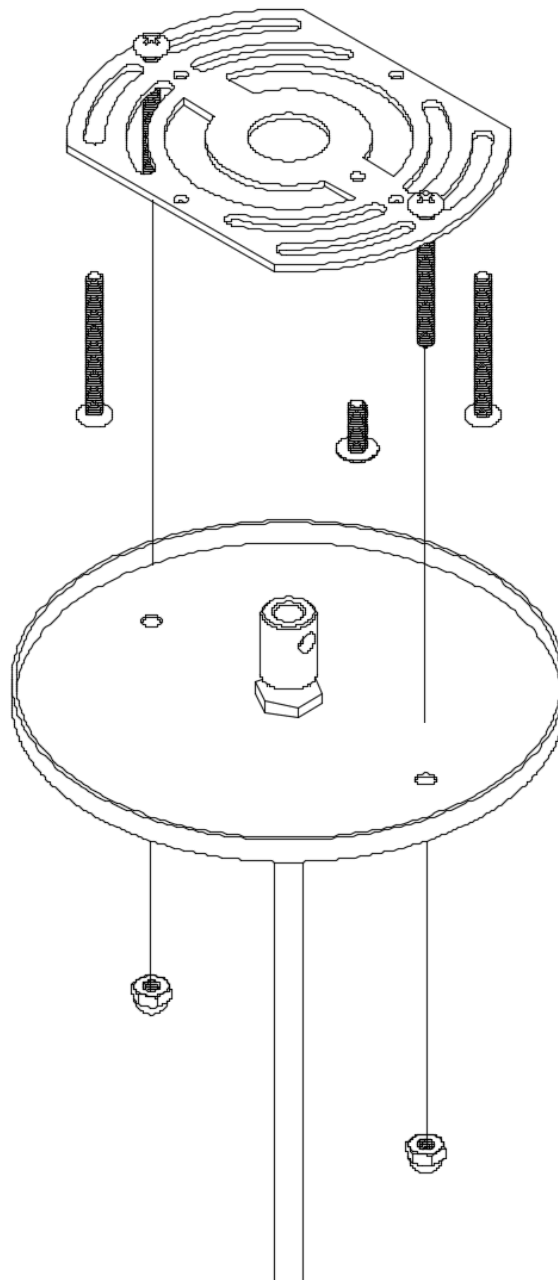



Step 1 Shut off the main electrical supply to the junction box from the fuse box/circuit breaker. Turning power off at the switch is not sufficient.	Step 2 Thread one pair of machine screws through 3 ½" spaced holes in backplate. Locate junction box in the ceiling.
Step 3 Using the remaining machine screws, attach the mounting plate to the junction box with the installed screw heads facing the ceiling.	Step 4 Pull conductor through strain relief at top of canopy until at desired hanging height, secure with set screw.
Step 5 Using the wire nuts provided, make electrical connections by following the electrical configuration table below. Ensure that all electrical connections are wrapped with ul listed electrical tape.	Step 6 Tuck the wiring into the junction box. Carefully align the two holes in the canopy with the mounting plate screws and then slip the canopy over the mounting plate screws.
Step 6 Attach and tighten the two acorn nuts to the mounting plate screws to secure the fixture to the ceiling.	Step 7 Install bulb and return power to fixture to confirm proper function.

Electrical Configuration

FROM SUPPLY	FROM LUMINAIRE
CONNECT BLACK OR RED (HOT) HOUSE SUPPLY CIRCUIT WIRE TO:	LUMINAIRE BLACK WIRE (HOT)
CONNECT WHITE (NEUTRAL) HOUSE SUPPLY CIRCUIT WIRE TO:	LUMINAIRE WHITE WIRE (NEUTRAL)

CONNECT GREEN INSULATED OR BARE COPPER (GROUND -)
HOUSE SUPPLY CIRCUIT WIRE TO GREEN GROUND SCREW ON CROSSBAR.