



GENERAL NOTES

This luminaire is UL listed for installation in dry or damp locations.

When installing luminaire, conform to all applicable local electrical codes, ordinances, and the National Electrical Code (NEC).

For your safety and proper operation of luminaire, read and understand all instructions completely before commencing installation of this luminaire.

Carefully unpack the luminaire and inspect for damage.

Use the enclosed gloves when handling the luminaire.

This product uses low voltage, integrated LED lighting.

Save these instructions for future reference.

CAUTION







This product should be installed only by a licensed electrician.

WARNING

The electricity must be turned off at the main fuse box before installing this luminaire. Turning power off using the light switch may not be sufficient to prevent electrical shock.

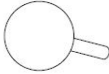
Use UL listed wire nuts for all wiring connections in this luminaire. Wrap wire nut connections with UL listed electrical tape.

INCLUDED COMPONENTS FOR INSTALLATION

	(1) luminaire body
	(1) backplate
	(1) mounting plate
	(2) ball assemblies
	(1) hex nipple
	(1) split lock washer
	(2) 1-1/2" #8 x 32 machine screws
	(2) 3/8" #8 x 32 & (2) 1/2" #8 x 32 set screws
	(3) wire nuts
	(1) Allen wrench

ASSEMBLY AND MOUNTING INSTRUCTIONS

STEP 1 | CUT POWER

Shut off the main electrical supply to the junction box from the fuse box/circuit breaker. Turning power off at the switch is not sufficient.

STEP 2 | ATTACH MOUNTING PLATE

Locate the junction box in the wall. Attach the mounting plate provided to the junction box using the 1-1/2" #8 x 32 machine screws provided. (Fig. 1) Ensure the mounting tabs are aligned vertically as shown in Fig. 1 to correspond with the proper orientation of the backplate.

NOTE: For horizontal installation of the luminaire, ensure the mounting tabs are aligned horizontally. For ceiling installation, ensure the mounting tabs are aligned to correspond with the proper orientation of the canopy.

STEP 3 | ATTACH BACKPLATE

Route the wires from the threaded coupling on the back side of the luminaire body through the hole in the backplate provided, ensuring the open side of the backplate is facing the mounting surface, and align the backplate with the threaded coupling. Route the wires through the split lock washer and then the threaded hex nipple provided, and thread the hex nipple into the coupling on the luminaire body.

NOTE: Tighten hex nipple by hand or using soft-touch pliers. Do not overtighten.

NOTE: Ensure the backplate is attached so that the set screw holes on the sides align with the mounting tabs of the mounting plate.

STEP 4 | CONNECT WIRES

Using the wire nuts provided, make electrical connections by following the electrical configuration table. (Fig. 2) Ensure that all electrical connections are wrapped with UL listed electrical tape.

Fig. 1

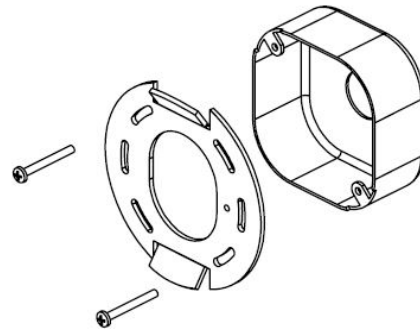
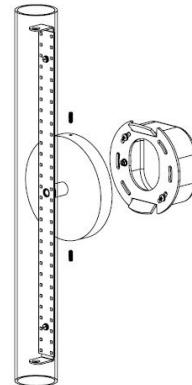

Fig. 2

FROM SUPPLY	TO LUMINAIRE
Connect black or red (hot) house supply circuit wire to:	Luminaire black wire (hot)
Connect white (neutral) house supply circuit wire to:	Luminaire white wire (neutral)
Connect green insulated or bare copper (ground) house supply circuit wire to:	Luminaire bare copper wire (ground)

Fig. 3



ASSEMBLY AND MOUNTING INSTRUCTIONS

STEP 5 | SECURE BACKPLATE

NOTE: 1/2" and 3/8" set screws included for mounting. Utilize the screw that works best for j-box site conditions.

Using the Allen wrench provided, thread one of the set screws into the upper hole in the backplate until the set screw is flush with the edge of the backplate. Hook the set screw onto the upper mounting tab on the mounting plate. Allow the luminaire to rest flush with the wall. Thread the second set screw into the lower hole in the backplate until the set screw is flush with the edge of the backplate. (See Fig. 3 on page 3)

STEP 6 | CONFIRM FUNCTION

Return power to the luminaire to confirm proper function. If further work is needed, be sure to turn off power to luminaire before proceeding. Once proper function is confirmed, cut power by repeating Step 1.

STEP 7 | INSTALL BALL ASSEMBLIES

Thread the ball assemblies provided into the metal bracket at each end of the glass. (Fig. 4)
Return power to the luminaire.

Fig. 4

